

Square Air Core RF Inductors

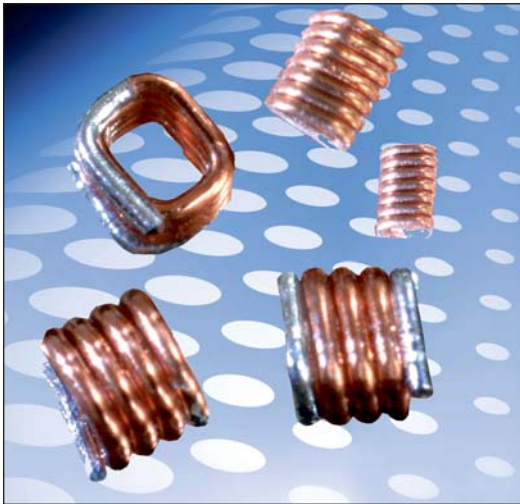

AS Series



GENERAL DESCRIPTION

AVX Square Air Core RF Inductors, part of the wound air core inductor family, are ideal for RF circuits, broadband I/O filtering, frequency selection, or impedance matching. The unique square cross section of the air core inductor provides better performance, and offers manufacturing advantages over toroidal coils.

FEATURES

- Square cross section construction
- Available in 0806, 0807, and 0908 sizes
- 20 Inductance values ranging from 5.5nH to 27.3nH
- High Q
- High Current
- Excellent SRF

APPLICATIONS

- RF Applications
- RF Circuits
- Broadband I/O Filtering
- Impedance Matching

HOW TO ORDER

AS ┆	06 ┆	05N5 ┆	J ┆	T ┆	R ┆
Air Core Inductor (Square Cross Section)	Size Size	Inductance 05N5 = 5.5nH 06N0 = 6.0nH 12N3 = 12.3nH	Tolerance G = 2% J = 5% K = 10%	Termination T = Sn/Ag over Cu (96.5% Sn, 3% Ag, 0.5% Cu)	Packaging R = 7 inch reel (2000 pieces per reel)

ELECTRICAL SPECIFICATIONS

Technical Data	All technical data related to an ambient temperature of +25°C
Inductance Range	5.5nH to 27.3nH
Inductance Tolerance	2%, 5%, 10%
Rated Current	2.7A, 2.9A, 4.4A
Operating Temperature	-40°C to +125°C
Termination	96.5% Tin/3% Silver over 0.5% Copper

ELECTRICAL SPECIFICATIONS

AVX P/N	Turns	Inductance (nH)	Tolerance (%)	Q min.	Test Freq. (MHz)	DCR max (mΩ)	SRF (GHz)	I _r max (A)
AS0605N5*TR	3	5.5	G, J, K	60	400	3.4	4.9	2.9
AS0606N0*TR	3	6	G, J, K	64	400	6	5.2	2.9
AS0608N9*TR	4	8.9	G, J, K	90	400	7	4.3	2.9
AS0612N3*TR	5	12.3	G, J, K	90	400	8	4.8	2.9
AS0615N7*TR	6	15.7	G, J, K	90	400	9	4.4	2.9
AS0619N4*TR	7	19.4	G, J, K	90	400	10	4	2.9
AS0706N9*TR	3	6.9	G, J, K	100	400	6	4.6	2.7
AS0710N2*TR	4	10.2	G, J, K	100	400	7	4	2.7
AS0711N2*TR	4	11.2	G, J, K	90	400	6.3	3.6	2.7
AS0713N7*TR	5	13.7	G, J, K	100	400	8	4.3	2.7
AS0717N0*TR	6	17	G, J, K	100	400	9	4	2.7
AS0722N0*TR	7	22	G, J, K	100	400	10	3.5	2.7
AS0808N1*TR	3	8.1	G, J, K	130	400	6	5.2	4.4
AS0812N1*TR	4	12.1	G, J, K	130	400	7	4.3	4.4
AS0814N7*TR	4	14.7	G, J, K	90	400	7.2	3	4.4
AS0816N6*TR	5	16.6	G, J, K	130	400	8	3.4	4.4
AS0821N5*TR	6	21.5	G, J, K	130	400	9	3.7	4.4
AS0823N0*TR	6	23	G, J, K	130	400	10	2.6	4.4
AS0825N0*TR	7	25	G, J, K	130	400	10	2.5	4.4
AS0827N3*TR	7	27.3	G, J, K	130	400	10	3.2	4.4

Note: 1. *Tolerance: G=±2%, J=±5%, K=±10%
 2. Inductance & Q measured on the HP4291B. With HP16193A test fixture.
 3. SRF measured using the HP8753E
 4. Operating Temperature range: -40°C to +125°C
 5. Electrical Specifications at 25°C
 6. MSL: Level 1



Square Air Core RF Inductors



AS Series

PHYSICAL DIMENSIONS

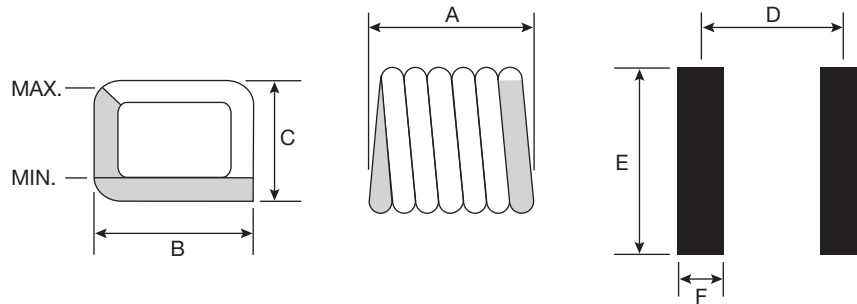

mm (inches)

Part Number	A	B	C	D	E	F
AS0605N5*TR	1.346±0.102 (0.053±0.004)	1.829±0.254 (0.072±0.01)	1.397±0.102 (0.055±0.004)	0.962 (0.038)	2.60 (0.102)	0.51 (0.020)
AS0606N0*TR	1.295±0.102 (0.051±0.004)	1.829±0.254 (0.072±0.01)	1.397±0.102 (0.055±0.004)	0.99 (0.390)	2.60 (0.102)	0.51 (0.020)
AS0608N9*TR	1.626±0.152 (0.640±0.006)	1.829±0.254 (0.072±0.01)	1.397±0.102 (0.055±0.004)	1.27 (0.050)	2.60 (0.102)	0.51 (0.020)
AS0612N3*TR	1.930±0.152 (0.076±0.006)	1.829±0.254 (0.072±0.01)	1.397±0.102 (0.055±0.004)	1.63 (0.064)	2.60 (0.102)	0.51 (0.020)
AS0615N7*TR	2.286±0.152 (0.09±0.006)	1.829±0.254 (0.072±0.01)	1.397±0.102 (0.055±0.004)	1.96 (0.070)	2.60 (0.102)	0.51 (0.020)
AS0619N4*TR	2.591±0.152 (0.102±0.006)	1.829±0.254 (0.072±0.01)	1.397±0.102 (0.055±0.004)	2.29 (0.090)	2.60 (0.102)	0.51 (0.020)
AS0706N9*TR	1.295±0.102 (0.051±0.004)	1.829±0.254 (0.072±0.01)	1.524±0.254 (0.060±0.010)	1.02 (0.040)	2.60 (0.102)	0.51 (0.020)
AS0710N2*TR	1.626±0.152 (0.064±0.006)	1.829±0.254 (0.072±0.01)	1.524±0.254 (0.060±0.010)	1.32 (0.052)	2.60 (0.102)	0.51 (0.020)
AS0711N2*TR	1.549±0.152 (0.061±0.006)	1.829±0.254 (0.072±0.01)	1.524±0.254 (0.060±0.010)	1.24 (0.049)	2.60 (0.102)	0.51 (0.020)
AS0713N7*TR	1.930±0.152 (0.076±0.006)	1.829±0.254 (0.072±0.01)	1.524±0.254 (0.060±0.010)	1.57 (0.062)	2.60 (0.102)	0.51 (0.020)
AS0717N0*TR	2.286±0.152 (0.09±0.006)	1.829±0.254 (0.072±0.01)	1.524±0.254 (0.060±0.010)	1.93 (0.076)	2.60 (0.102)	0.51 (0.020)
AS0722N0*TR	2.591±0.152 (0.102±0.006)	1.829±0.254 (0.072±0.01)	1.524±0.254 (0.060±0.010)	2.29 (0.090)	2.60 (0.102)	0.51 (0.020)
AS0808N1*TR	1.473±0.152 (0.058±0.006)	2.134±0.152 (0.084±0.006)	1.829±0.152 (0.072±0.006)	1.12 (0.044)	2.80 (0.110)	0.64 (0.025)
AS0812N0*TR	1.854±0.152 (0.073±0.006)	2.134±0.152 (0.084±0.006)	1.829±0.152 (0.072±0.006)	1.45 (0.570)	2.80 (0.110)	0.64 (0.025)
AS0814N7*TR	1.549±0.152 (0.061±0.006)	2.134±0.152 (0.084±0.006)	1.829±0.152 (0.072±0.006)	1.24 (0.049)	2.80 (0.110)	0.64 (0.025)
AS0816N6*TR	2.210±0.152 (0.087±0.006)	2.134±0.152 (0.084±0.006)	1.829±0.152 (0.072±0.006)	1.83 (0.072)	2.80 (0.110)	0.64 (0.025)
AS0821N5*TR	2.565±0.152 (0.101±0.006)	2.134±0.152 (0.084±0.006)	1.829±0.152 (0.072±0.006)	2.18 (0.086)	2.80 (0.110)	0.64 (0.025)
AS0823N0*TR	2.235±0.152 (0.088±0.006)	2.134±0.152 (0.084±0.006)	1.829±0.152 (0.072±0.006)	1.90 (0.075)	2.80 (0.110)	0.64 (0.025)
AS0825N0*TR	2.972±0.152 (0.117±0.006)	2.134±0.152 (0.084±0.006)	1.829±0.152 (0.072±0.006)	2.57 (0.101)	2.80 (0.110)	0.64 (0.025)
AS0827N3*TR	2.972±0.152 (0.117±0.006)	2.134±0.152 (0.084±0.006)	1.829±0.152 (0.072±0.006)	2.57 (0.101)	2.80 (0.110)	0.64 (0.025)

Square Air Core RF Inductors



AS Series

PERFORMANCE SPECIFICATIONS

AS06

Inductance vs. Frequency

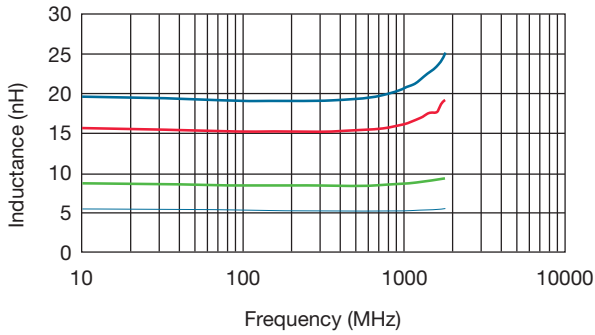

Typical Q vs. Frequency

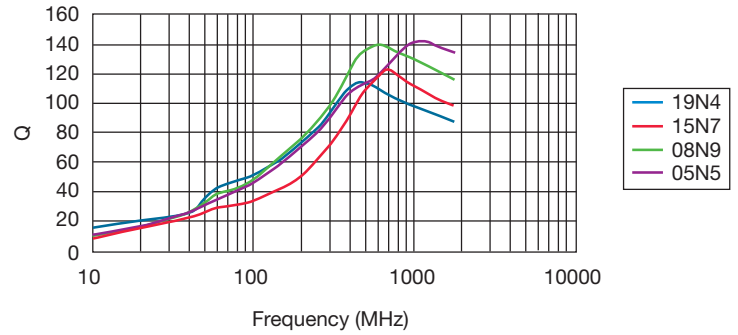

AS07

Inductance vs. Frequency

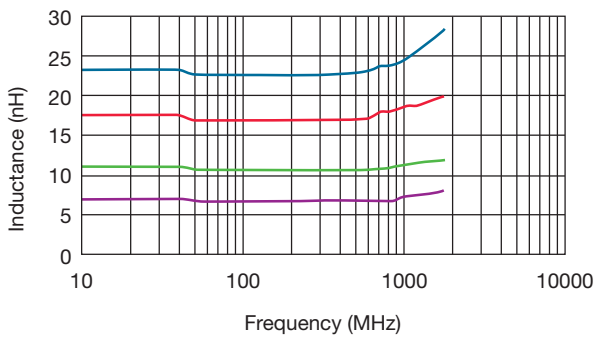

Typical Q vs. Frequency

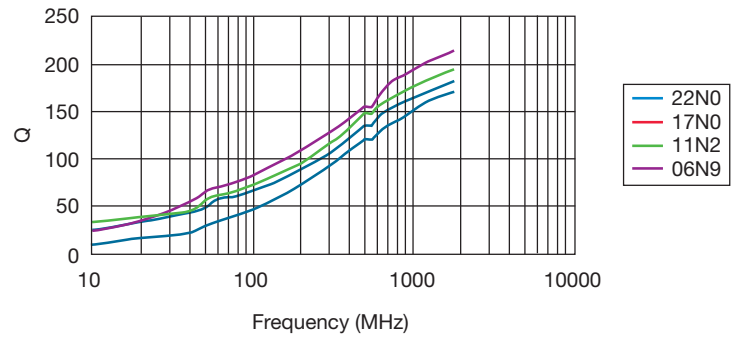

AS08

Inductance vs. Frequency

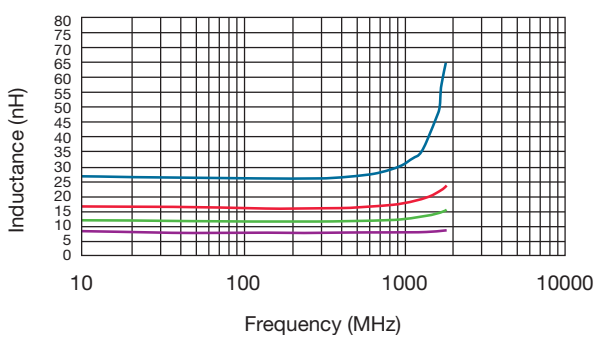

Typical Q vs. Frequency

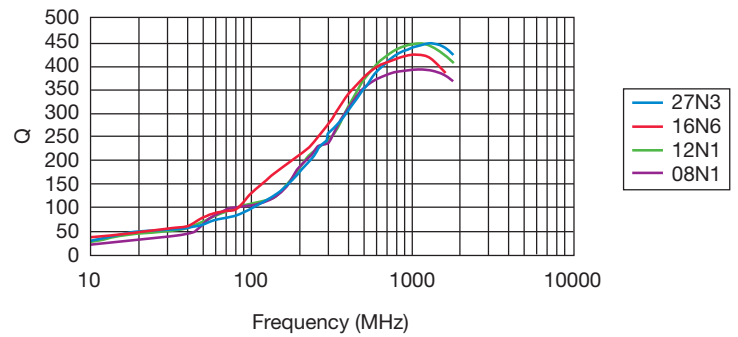

Square Air Core RF Inductors



AS Series

TYPICAL RoHS REFLOW PROFILE

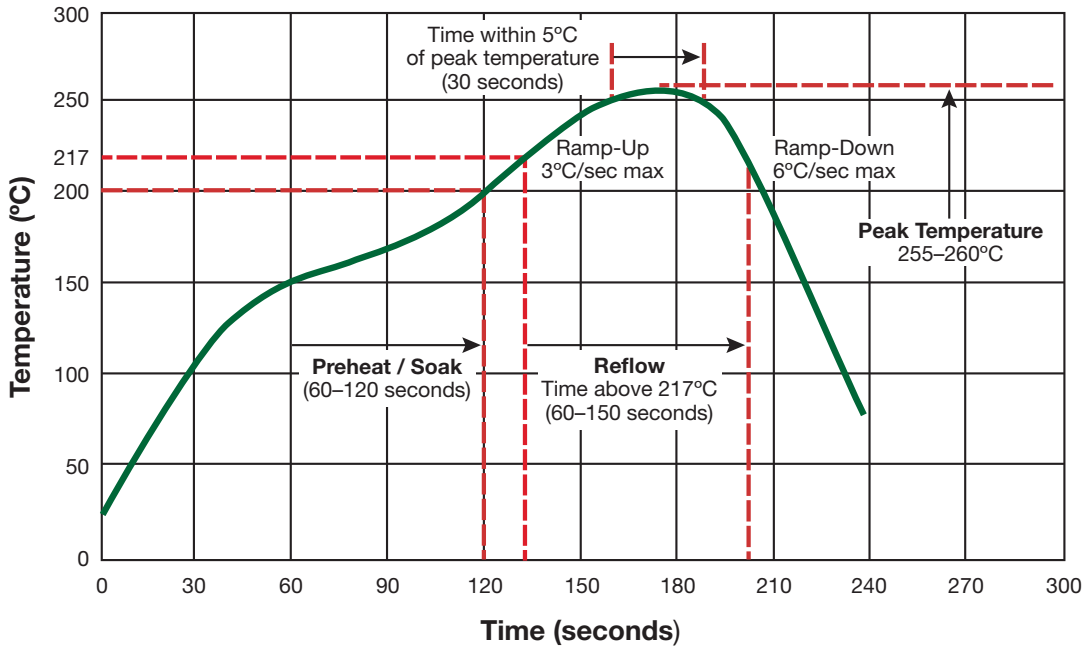

PACKAGING SPECIFICATIONS

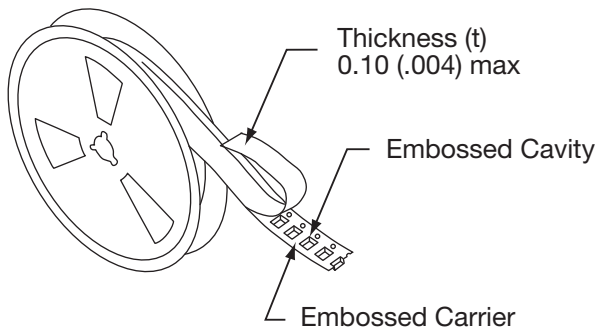

- The force for tearing off cover tape is 10 to 130 grams in the arrow direction

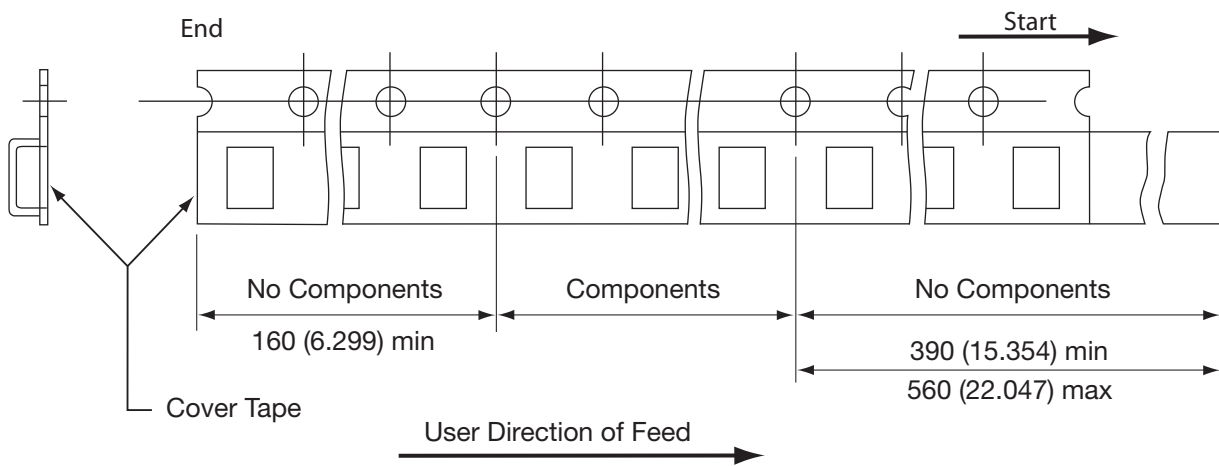
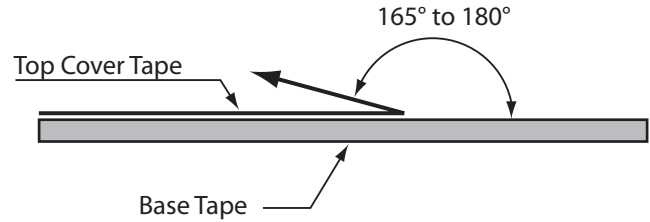

CARRIER TAPE REELS

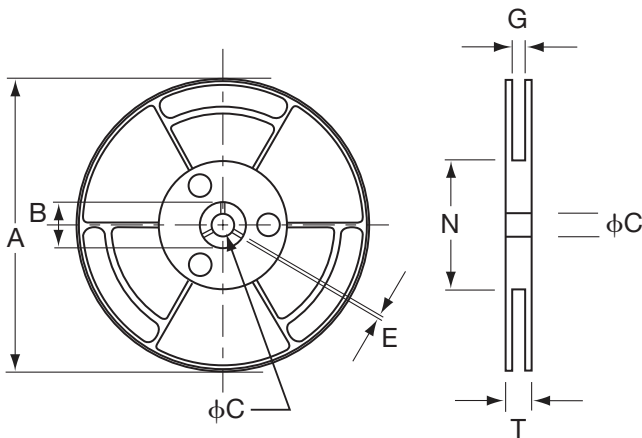

DIMENSIONS OF CARRIER TAPE

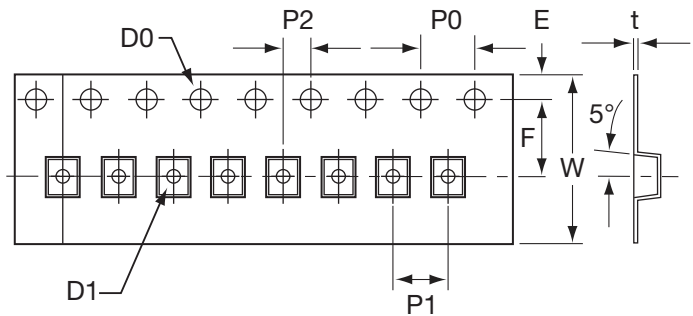

mm (inches)

ITEM	A	B	C	G	N	T	W	E	F	P1	P2	P0	D0	D1	t
DIM.	178 (7.008)	25 (0.984)	15 (0.591)	12.5 (0.492)	75 (2.953)	16.4 (0.646)	12.0 (0.472)	1.75 (0.069)	5.50 (0.217)	4.00 (0.157)	2.0 (0.079)	4.0 (0.157)	1.5 (0.059)	1.0 (0.039)	0.23 (0.009)
TOL.	±2.0 (0.079)	±1.0 (0.039)	±0.5 (0.020)	±1.5 (0.059)	±2.0 (0.079)	±1.5 (0.059)	±0.2 (0.008)	±0.1 (0.004)	±0.1 (0.004)	±0.1 (0.004)	±0.1 (0.004)	±0.1 (0.004)	±0.1 (0.004)	±0.1 (0.004)	±0.05 (0.020)